

INSTALLATION GUIDELINES

- Since Timely 6-8 frames are reversible, the jambs can be flipped end for end to achieve proper swing.
- If a closing device is being used, you will need a TA-10 or TA-12 Reinforcement Bracket, and it must be installed before installing the casing or the header.
- The frame should always rest on the finished floor. If the floor is not finished, shim the frame to compensate for floor thickness.
- The casing can become damaged or dimpled if struck directly in the center by a hand or rubber mallet.
- Frames used for exterior exposure require additional painting for proper weatherproofing.
- Frame, door and hardware must be installed at the same time or warranty is invalid.
- Remove excess foam backing from strike cutout locations by carefully using a utility knife.

Required Tools

- 6' magnetic level
- 3' level
- Electric screw gun
- #3 Phillips tip for hinge screws
- #2 Phillips tip for drywall screws
- Phillips head screwdriver
- Pliers
- Tape measure
- Pry bar
- Safety glasses
- Utility knife

1. Check the rough opening
 - a. The opening has to be 1-1/4" over in width and 1" over in height.
 - b. **Since Timely's 6-8 frames are reversible, the jamb can be flipped end for end to achieve proper swing.**
 - c. There are tabs at each end.
 - d. The tabs on the bottom must be bent down so the frame sits flush to the finished floor.

2. Sleeve the header over the rough opening
 - a. Squeeze the header and closure to the wall for a snug fit. Make sure the rabbet on the header will match the rabbet on the hinge jamb.

Note: If using a TA-12 Reinforcement Bracket, install before sleeving header.

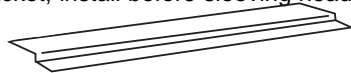

TA-12 Bracket

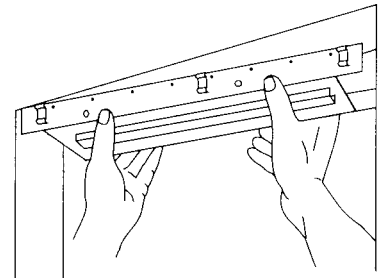

3. Sleeve the hinge jamb over the wall and adjust to wall thickness by squeezing the hinge jamb and closure to the wall for a tight fit.
 - a. **Try to place the hinge jamb close to the stud. This will allow more room for adjustment in future steps.**
 - b. Align the slots in the header with the two tabs on the hinge jamb.
 - c. Pull the header tight to the hinge jamb.
 - d. Apply the strike jamb in the same way the hinge jamb was applied.
 - e. **The frame should always rest on the finished floor. If the floor is not finished, shim the frame to compensate for floor thickness.**

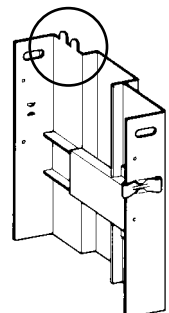
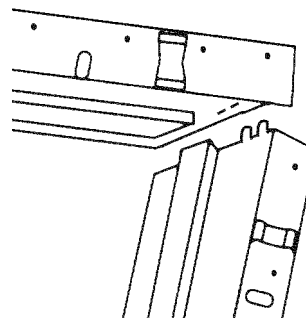

Continue to step 4

4. Working from the door side, place a level on the header.

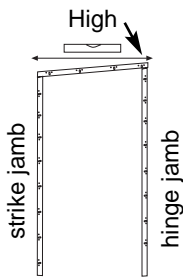

If the level indicates that the hinge jamb side is higher than the strike jamb, fasten one screw in the header over the hinge jamb. Align the corner of the hinge jamb with the corner of the header and fasten at an upward angle at the top of the hinge jamb to be sure the hinge jamb is snug to the header. On the opposite side of the hinge jamb, repeat the above steps to attach the closure pieces.

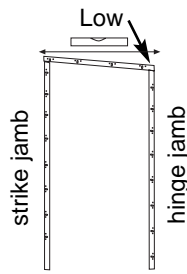

If the level indicates that the hinge jamb is lower than the strike jamb, lift the header until it is level and fasten one screw in the header over the hinge jamb. Lift the hinge jamb tight to the header. Align the corner of the hinge jamb with the corner of the header and fasten at an upward angle at the top of the hinge jamb to ensure that the hinge jamb is snug to the header. On the opposite side of the hinge jamb, repeat the above steps when attaching the closure pieces.

a. Plumb the hinge jamb using the 6' magnetic level. Apply one screw to the bottom of the frame. With the tape measure, check the distance from the hinge jamb to the strike jamb at the bottom, making sure the 36" i.e., 3/0 door or larger dimension requirement is met. Apply one screw at every clip on the hinge jamb of the door side only. **TO MAINTAIN FIRE RATING REQUIREMENTS, the frame must be anchored with one fastener at each clip, or every 11" ± 1/4" and 2" from any end. Minimum #6 drywall screws recommended. Length of screws must be sufficient to penetrate into steel stud by at least 1/2" and into wood stud at least 1". Frame meets U-B-C-7-2-97, UL 10 C, UL 1784 Smoke Rating & CBC 7-2 1998 PART 1 & 2.**

5. Hang the door.

Close the door in order to align it with the frame. Begin with the header, using a screwdriver through the alignment slot closest to the strike jamb. Create an equal gap between the door and frame. Fasten the header above the strike jamb and the remainder of the header at every clip on the door side only.

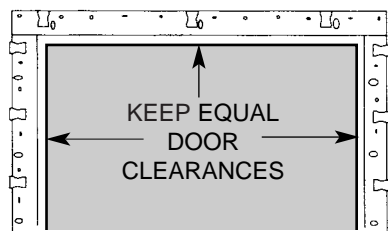

6. Lift the strike jamb tight to the header. **It is important that the corner of the header and the corner of the strike jamb are properly aligned.** To pull the strike jamb tight to the header, fasten at the top of the strike jamb at an upward angle.

- Create an equal gap between the door and frame at the strike location and fasten.
- Create an equal gap between the door and frame at the bottom of the strike jamb and fasten.
- Fasten the remainder of the strike jamb at every clip on the door side only.

7. After fastening the door side, fasten the opposite side of the frame.

- Pull the header tight to the strike jamb and apply a fastener at the corner of the header.
- Fasten the remainder of the header at every clip.
- Make certain that the bottom of the hinge jamb is square to the wall and fasten.
- Fasten the remainder of the hinge jamb at every clip.
- Align the corner of the strike jamb with the corner of the header and fasten at the top of the strike jamb. Fasten after making certain that the bottom of the strike jamb is square to the wall.
- Fasten remainder of the strike jamb at every clip

Use Timely Part No. TA-10

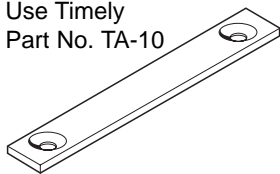

8. Now apply the casing, starting with the header. **Note:** If installing the TA-10 Reinforcement Bracket, install before putting on casing.

- The casing can become damaged or dimpled if struck directly in the center by hand or rubber mallet.**
- Center the header casing. Allow for equal distance on both ends. Roll the casing over one clip toward the door with a tap of the hand, securing the casing on the center clip.
- Slide both upright casings with Mitergard® (available for TA-8 casings only) into header casings. For all other casings, insert separate corner pieces into header and upright casings. Then anchor the header casing using the same rolling motion toward the door.
- Anchor the upright casings starting at the top. Make sure the casings are clipped over the outside and, with a hand tap, on the inside.
- The casing can be adjusted slightly to make sure all miters are tight and secure.

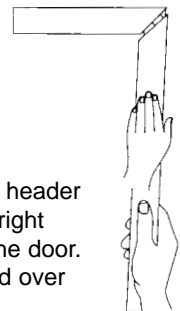

9. Apply the casings to the opposite side.

11. The final task is to install the adjustable T-strike.

- The strike has a "C" section and cup section which can be moved back and forth, allowing 1/4" adjustment.
- Fasten the C-section in the center of the adjustment. Close the door and adjust as necessary.

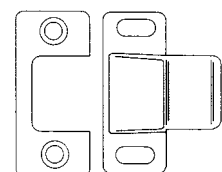

10. Apply silencers to the frame.